

# A-60

## Professional photovoltaic modules for small installations



It is constituted by high efficiency square monocrystalline silicon photovoltaic 6" half-cells, which are capable of producing energy with only 4%-5% solar radiation. This feature assures a production that extends from dawn till dusk, thus taking maximum advantage of all the useful power that is supplied by the Sun.

The multiple redundant connections in the front and rear sections of each cell serve to guarantee the reliability of the module circuit.

These modules can withstand the most severe weather conditions and will function efficiently without interruption throughout their long life span due to their sturdy construction with lateral frames of anodised aluminium and glass front in compliance with strict quality standards.

The series of 36 high efficiency cells is completely encased in EVA and protected against dirt, humidity, and impacts by a special front section made of anti-reflecting safety glass with low iron content and a back-sheet in its rear section, which make it completely watertight.

The all-weather connections box with its positive and negative terminal has two built-in bypass diodes, which prevent the possibility of breakdown in the cells and the circuit by the partial cross-hatching of one or several modules within a set, thereby enhancing the effectiveness of the module in all circumstances.

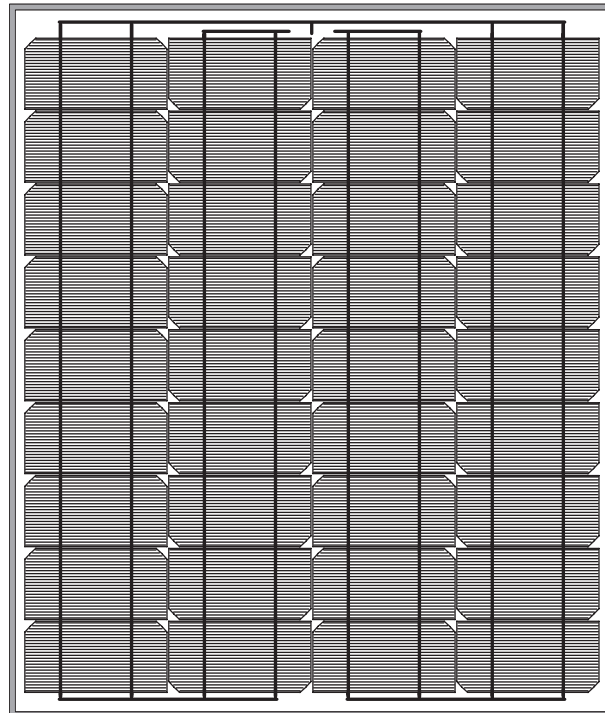

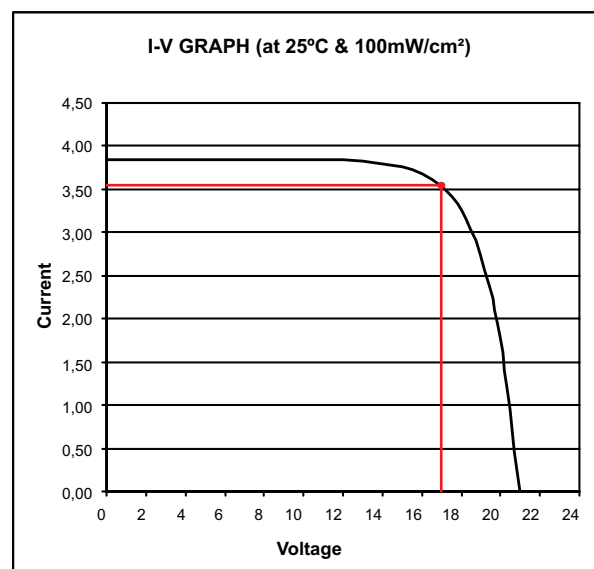

<b>Electrical Specifications</b>	
Power (W at test $\pm 10\%$ )	60 W
Number of serial cells	36
Maximum Power Current (Imp)	3,55 A
Maximum Power Voltage (Vmp)	16,9 V
Short Circuit Current (Isc)	3,85 A
Open Circuit Voltage (Voc)	21,0 V
Short Circuit Temperature Coefficient ( $\alpha$ )	1,73 mA/°C
Open Circuit Voltage Temp. Coefficient ( $\beta$ )	-84,08 mV/°C
<b>Physical Specifications</b>	
Size (length x width x thickness)	778x659x35mm
Weight (aprox)	6,2 Kg.
Standard Test Conditions define as: irradiance= 1.000 W/m <sup>2</sup> , AM 1.5 sprum 25°C Cell Temperature	

NOTE: This data could be modified without advising.

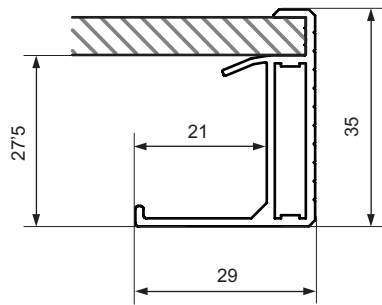
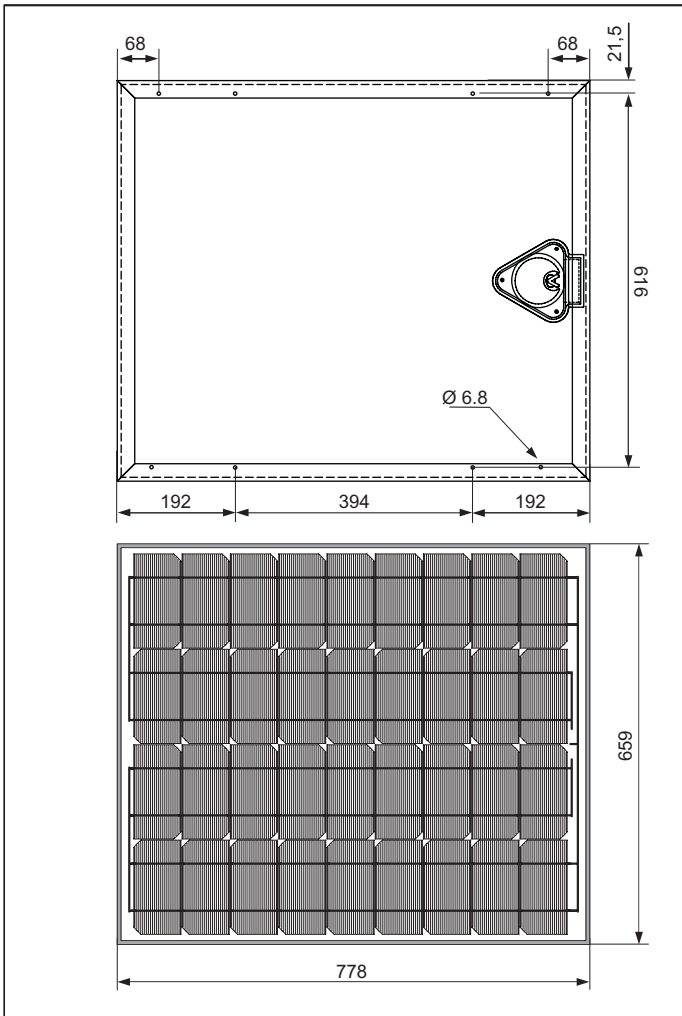
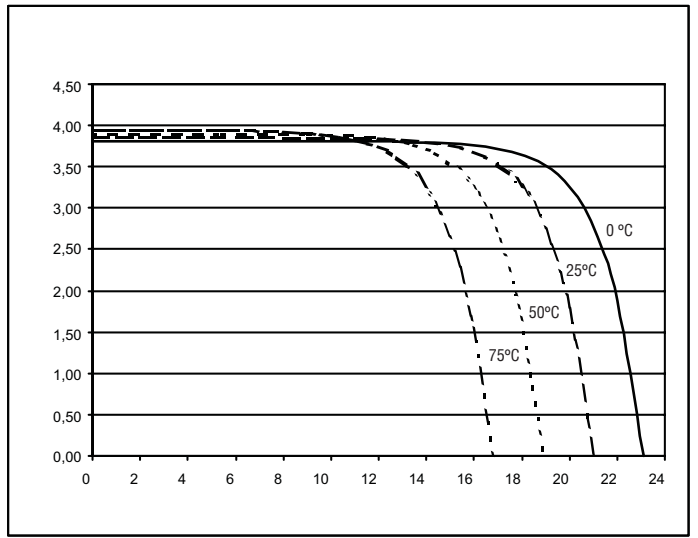
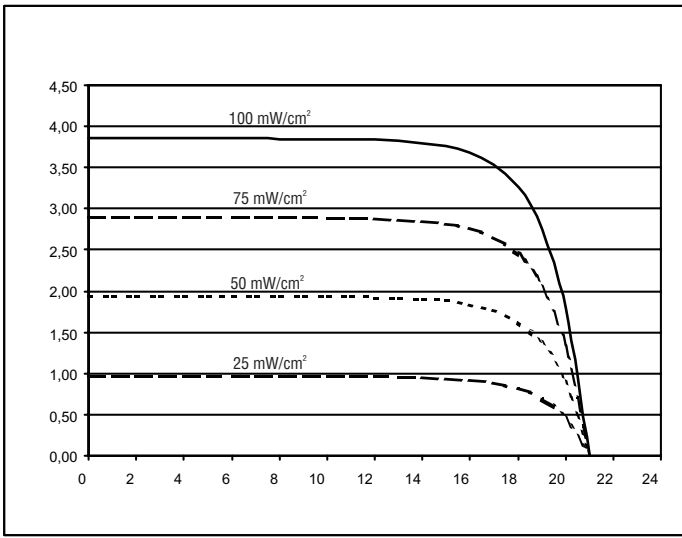



PHOTOVOLTAIC MODULE	
Model	A-60
Max Power	60 W
Isc	3,85 A
Voc	21,0 V
Imp	3,55 A
Vmp	16,9 V
Max V Syst.	600 Vdc
Ser. Number	12345678A
SPECIFICATIONS AT 1000W/m² 25°C AM 1.5	
 	
MADE IN SPAIN	

