

BioLet[®]

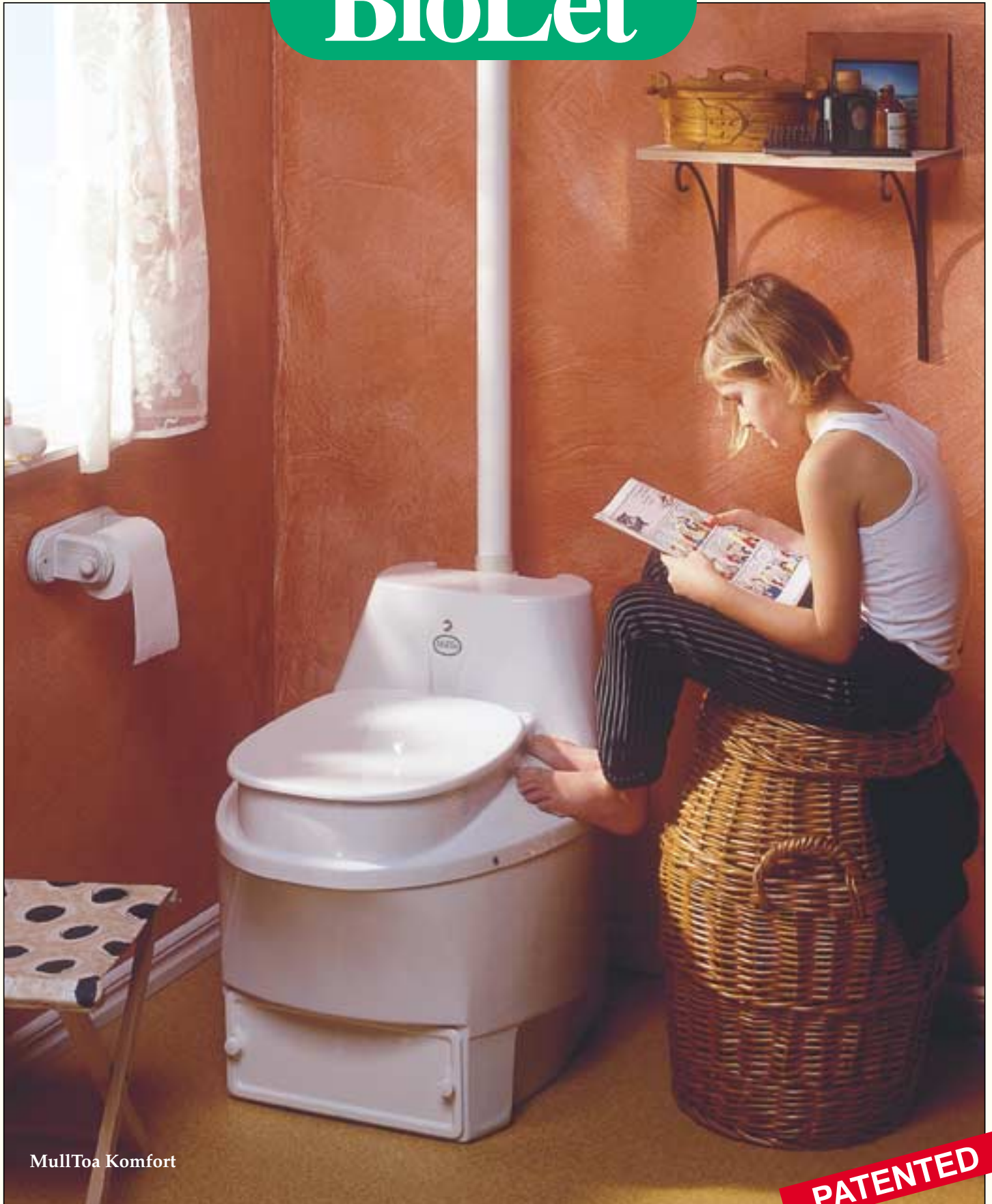

MullToa Komfort

PATENTED

The most advanced self-contained composting toilet
No water, no chemicals, no odor!

THE NATURES LAW AND BIOLET:

All Composting Toilets Are Not the Same.

BioLet, with over 30 years on the market, is the most popular composting toilet in the world and is the first one to pass various governmental and independent laboratory tests in Scandinavia and the United States and around the world. BioLet composting toilets won a widely recognized gold medal at the International Inventor's Exhibition in Geneva, Switzerland for the year's best invention in the environmental field.

Since then, BioLet composting toilets have continually been improved by our qualified engineers and the BioLet Komfort, which is tested and Certified by NSF International, (the most widely recognized and respected independent certification organization for public health safety) is the most advanced composting toilet on the market. For comfort, the environment and economics, BioLet is one of the best investments that you will ever make.

BioLet Works with Nature

Nature does its own composting. In warm weather, natural aerobic soil microorganisms digest and transform leaves, grass and other organic debris into a hygienic, inoffensive soil component called "compost". Compost provides the nutrients for new plant growth and holds moisture in the soil. Gardeners around the world utilize this process when they compost yard and garden wastes and use the compost as fertilizer. BioLet unites this natural process with modern technology to accelerate and optimize biological decomposition, evaporate excess liquid and exhaust odours and water vapour all within an attractive home appliance that is easy to use and economical to operate.

It's Easy!

The process is initiated by establishing healthy compost inside the mixing chamber. A convenient package of Compost Starter containing the correct blend of organic materials is poured through the toilet seat opening into the mixing chamber. The ventilation pipe is connected, the electrical cord is plugged into a standard grounded outlet and the BioLet is ready for use. Mechanical mixing and aerating makes the material porous and sifts the composted portion into the collecting tray so that

the uncomposted portion and the dry, safe portion are kept separate. In the BioLet Komfort and the BioLet KomfortXL a microswitch controlled motor turns the internal mixers automatically. In the Standard Model a convenient handle operates the mixers with a few gentle turns after each use. A small heater with an adjustable thermostat and an efficient fan work together to provide sufficient heat and air flow to reduce human waste by up to 95%. Excess liquid is evaporated while warm temperature

is maintained inside the compost; the fan exhausts all odour and provides oxygen for the microorganisms. The dry, much reduced remainder, or compost, collected in the tray can safely be recycled to the soil where the nutrients will be utilized for new plant growth. When used primarily in a part time vacation home or cottage, the BioLet toilets will handle the waste for up to six people, with possible occasional overload. In a full-time residential setting the BioLet Komfort XL has been certified by the National Sanitation Foundation to handle the waste for four people. The BioLet toilet can not be damaged by freezing nor will it rust or corrode as all



of its components are of stainless steel or high impact polystyrene plastic. In applications where electricity is not accessible or impractical the BioLet Separera may be installed. It utilizes a ventilation system to evaporate liquids and provide odourless decomposing. Any excess liquid is discharged through a provided drain. Dry and beneficial compost is obtained without electricity.

Empty the Tray Only Once a year!

Usage and local temperature will determine the actual frequency, but in a part-time vacation home or cottage, annual removal of the compost is usually more than sufficient. During this period, human waste and paper have been completely transformed into valuable compost. When the mixing chamber is full, simply remove the front cover of the collecting tray, pull out the tray containing the processed compost and mix it into the soil where its nutrients will safely generate new plant growth. Instead of polluting the ground, oceans, lakes and streams the BioLet transforms human waste into a valuable material that is safely returned to the soil to enrich it.

BIOLET! THE BEST S

BioLet is the result of more than 30 years of development in close contact with the user.

Choose the right model

BioLet looks like an ordinary toilet with a modern design which makes it is easy to fit into the bathroom. When choosing the right model you have to consider two things: the capacity, how many people will use the toilet and is it in a permanent home or a cottage situation. Also you can choose the standard unit where you have to turn the handle after each use and adjust the thermostat according to how many people are using the toilet or choose the BioLet Komfort where this is done automatically. Always choose a toilet with larger capacity than needed even if all models can handle a certain time of over-load. The bathroom should have an temperature of +18 C while the toilet is being used. Before leaving the house switch off the toilet and the temperature in the bathroom can be freezing without any damage to the toilet. The electrical consumption is low so the cost of running the toilet is also very low. BioLet is manufactured in polystyrene plastic and stainless steel so it does not freeze or rust. With its smooth design makes it easy to keep clean.

The princible of BioLet.

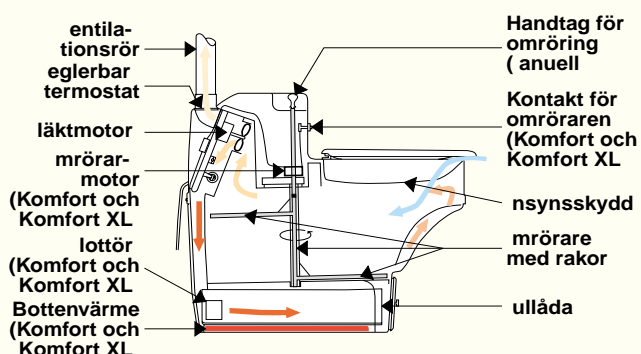

The patented re-circulation of warm air and the adjustable thermostat which can be set according to the number of people using the toilet makes the running cost very low. The fan pushes warm air under and around the compost in order for the compost to have the optimum temperature for fast composting and evaporation of the fluid. The efficient mixing of the compost ensures enough oxygen for the composting process.



BIOLET STANDARD

The BioLet Standard is the original BioLet composting Toilet. While we have added automatic mixing to some models, the BioLet Standard has a conveniently located handle that is turned after each use. This easy maintenance insures accurate mixing of the compost and accelerates the microbes activity. Equipped with a heating element, a fan and a thermostat, the BioLet Standard has all the basics for good composting. As is true of all BioLet models, the Standard is equipped with a compost cover that hides the material from view and opens automatically when sitting. Another feature engineered exclusively by BioLet and with a seat height of only 50 cm, the BioLet Standard is very comfortable to use and it has no awkward foot- or stool to hamper children and the elderly. It's reliable and proven technology makes the BioLet Standard a good investment for both you and the environment.

Capacity: 3-4 people in a vacation home

Electrical consumption: 250 W/h

Measurement: H 66xW 55xD 74 cm.

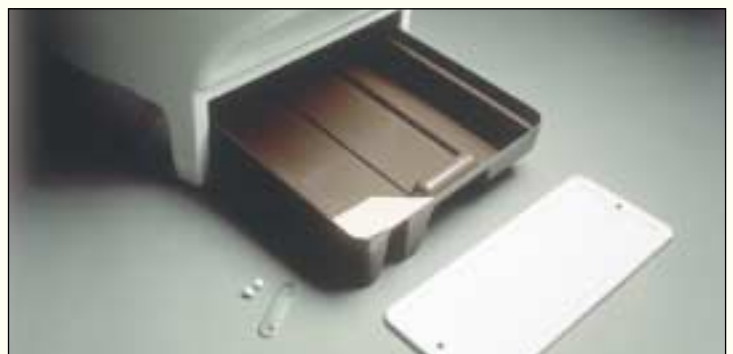

The compost in the tray is easy to remove and empty. (BioLet Komfort, BioLet Komfort XL and BioLet Standard.)

SELLING COMPOSTING TOILETS



BIOLET KOMFORT

The elegant, fully automatic BioLet Komfort decorates every bathroom with its pleasing compact design, all within an attractive body of durable, polished polystyrene plastic. BioLet Komfort XL is equipped with 3 mixing arms with "cutting blades" to help break-down toilet paper and keep the compost in an airy, homogenous state, and a float switch that operates the heaters when excess liquid is detected. And an extra heating element in the bottom to help evaporate the excess liquids. The BioLet Komfort is equipped with a patented grate which can be closed when emptying the composting tray preventing compost from falling into bottom of the toilet and also keeps the liquid in the compost in order to keep it moist.

Capacity: 4 people in a vacation home or 2-3 people in a permanent home.

Electrical consumption: 350 W/h

Measurement: H 65xW 55xD 71 cm.



BIOLET KOMFORT XL

BioLet Komfort XL is the most advanced composting toilet and sets the standard for composting toilets around the world. Tested and approved by the National Sanitation Foundation, the BioLet Komfort XL was proven to be the safest composting toilet on the market and exceeded all requirements by a wide margin. Its design has been voted the most user-friendly of all high capacity composting toilets. As is true of all BioLet models, the Komfort XL is equipped with a compost cover that hides the material from view and opens automatically. For those who need extra capacity, the BioLet Komfort XL is the right choice. Equipped with the same automatic features as the BioLet Komfort, The BioLet Komfort XL has 40% larger composting chamber.

Capacity: 4-6 people in a vacation home or 4 people in a permanent home.

Electrical consumption: 350 W/h

Measurement: H 66xW 65xD 81 cm.



Compost-cover, all models of Biolet and Separera are equipped with the automatic compost Cover.

LET IN THE WORLD!

The BioLet is easy to install

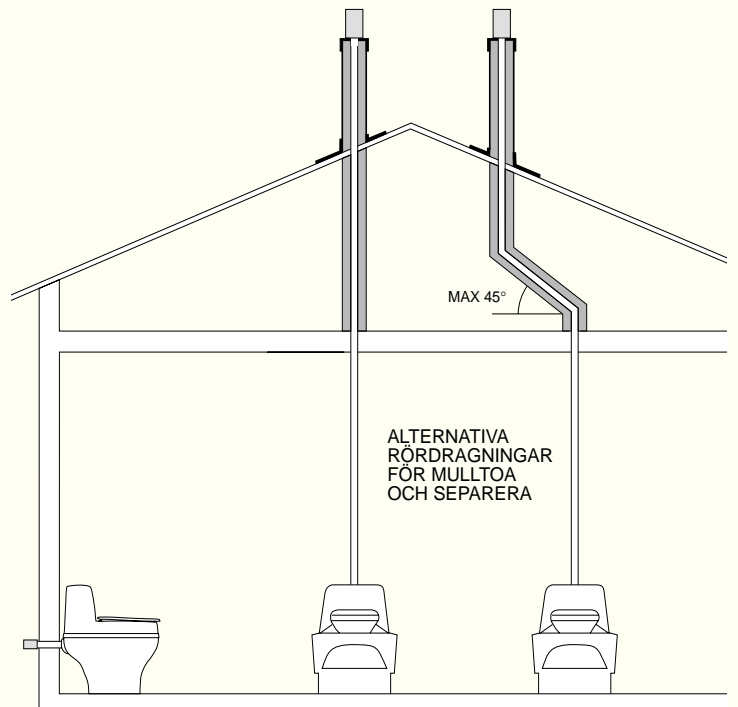
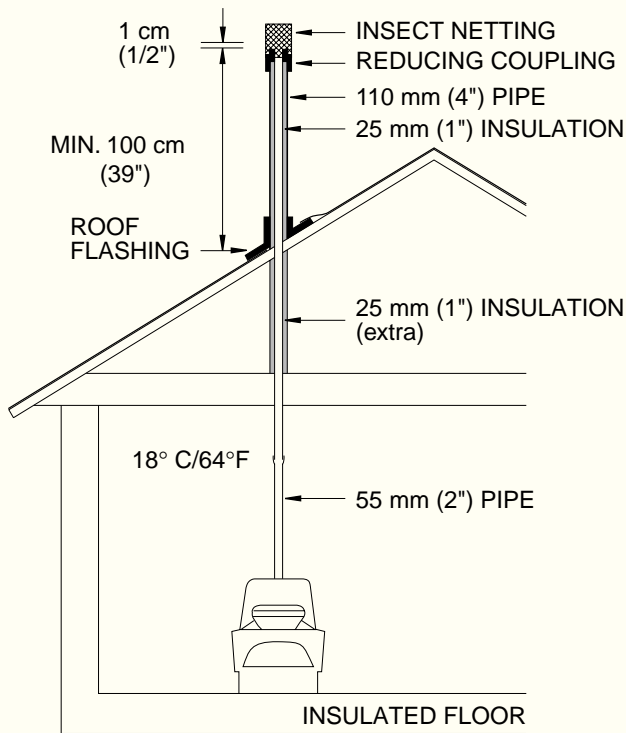

Vägg-genomföring endast för Separera.

Använd inte mer än 2 st rörkrökar och ej över 45° vinkel, för att säkra funktion och

The BioLet is easy to install

Make a hole in the ceiling and roof for the ventilation pipe. Push the outer pipe into the roof flashing and seal it carefully. Empty the bag of compost starter into the BioLet. (See instruction for starter kit). Plug into grounded outlet. The BioLet is ready to be used!

Your BioLet includes an easy to understand owners manual which guides you through every step of the installation, use and maintenance of the BioLet composting toilet.

Your installation kit contains:

- 4,4 m of 55 mm ventilation pipe (white)
- 1,0 m of 110 mm
- 1 flexible roof flashing
- 1 bag of compost starter mix
- 1 Insect netting



The BioLet has exceeded critical test standards for hygiene, function, capacity, material and ease of use. The BioLet is the only self-contained composting toilet that has been approved by health, environmental and consumer authorities in Scandinavia, where more composting toilets are installed than anywhere else in the world!

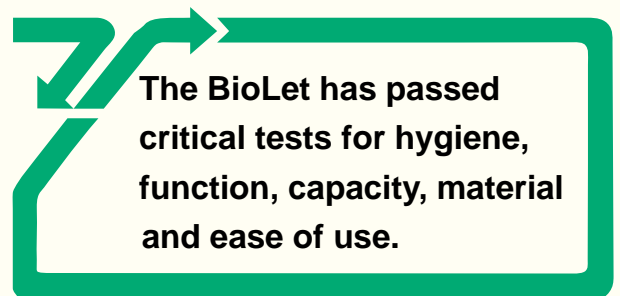

WARRANTY: Two years limited warranty.

The right is reserved to alter the design and dimension.

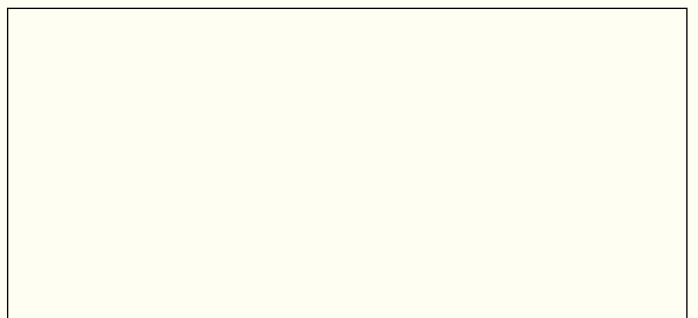

SEPARERA



Separera 33

A complete system for the summerhouse
easy to use and environmentally friendly.

FUNDAMENTALS FOR SEPARERA MODELS:

Really obvious

The unique thing with separation is that it takes care of the faeces and urine in separate ways. When you are using a Separera the idea is that the waste is separated, (urine and faeces), while it is being used. This means that the toilet consists of two separate chambers, one inside the toilet for faeces and toilet paper and one container outside the house for the urine.

Hygienic and comfortable

The urine bowl is big (width 33cm, length 18cm, depth 19cm) all to avoid splashing while it is being used. This is very important as a matter of hygiene. The chamber for faeces is specially designed for good function and easy handling. The container has a cover with a handle that makes it easy to carry out and replace with the other chamber. The two chambers should be used alternatively. The fan provides the compost with oxygen as well as dries out some of the moisture at the same time as it makes the bathroom odour free.

Faeces

In normal use a family of four people produces about 7 litres per week. This has to be composted for about 6 months before it can be used as compost in the garden. The Separera is delivered with two compost chambers; one to be used in the toilet while the other one is standing outside for composting.

Urine

In normal use a family of four people produces about 35-litre urine per week. Urine is sterile and very good as a fertilizer when it is diluted with 8 times of water. This

dilution is done automatically through the injector installed on top of the tank for the urine. 35 litre of urine have same quantity of fertilizing substance as 3-kg fertilizer and therefore it is very important to spread it over as big area as possible. These in order to avoid that the solution reaches groundwater or other water courses. The ground temperature should be at least 6°C when the solution is spread in order for the vegetation to absorb the nutrients.

Install it yourself

All needed for the ventilation through the wall behind the toilet is included, 0,5 m pipe and insect-netting. In order to go through the ceiling, (to get an natural draught) you will need the BioLet installation kit and the special adapter. Two different alternatives for the drain hose from the toilet either, through the floor under the toilet or out in the back of the toilet and through wall. When installing Separera 40 it is necessary to make a hole in the floor in order to connect composting chamber and urine container to the toilet. Always contact your local environmental health officer before installation!

Choosing model

When choosing model consider how many people will be using the toilet and for how long period of time. Also if it is possible to put the chamber in the basement or not. All models have a fan of 18W which provides good ventilation, it is also available in 12 Volt. All models can be used in a unheated room and will not freeze in wintertime but consider the problem regarding the urine in wintertime. All models have compost cover so you will not see the waste, this opens automatically, when you sit down.

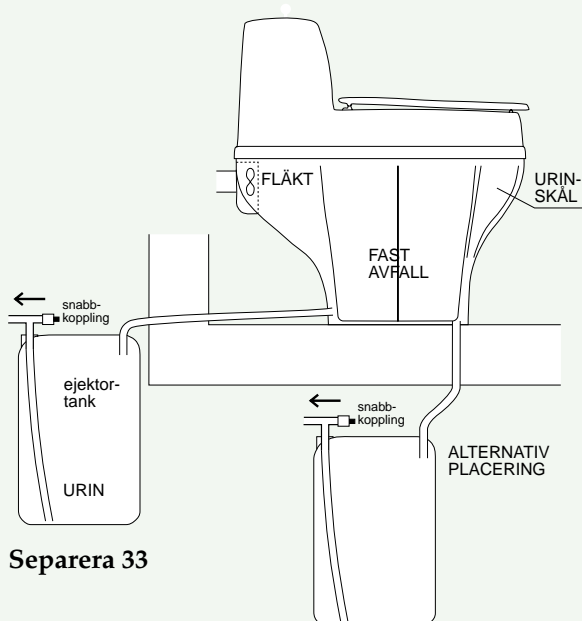

Separera 33

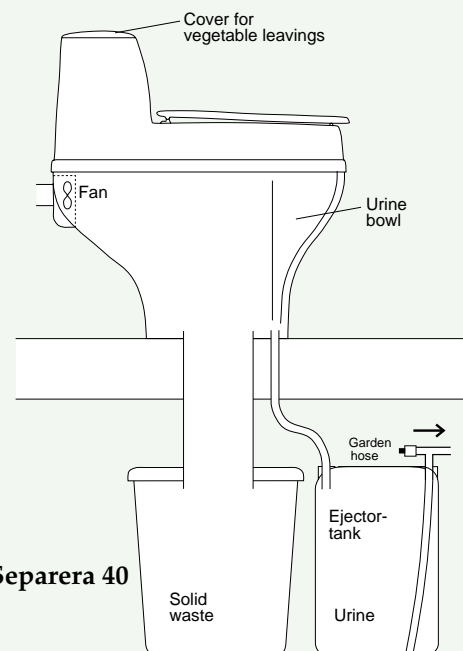

Separera 40

BIOLET SEPARERA



SEPARERA 33

This model has a elegant design at the same time as it is very functional. The toilet is equipped with a compost cover so when the toilet seat is opened you only see a white cover. When you use the toilet (you always have to sit down) it automatically opens the compost cover and closes afterwards. The chamber for the solids is divided into two sections. While one part of the chamber is being used, is the other one composting the solids. The chamber has a permanent cover with a handle for easy handling when emptying the compost. The volume is big enough for four people in a cottage, requiring only to be emptied once a year. The ejector tank for the liquid is placed either outside the house or underneath the floor. When the ejector tank is full you just hook it up to the garden hose and you can water (fertilize) the lawn. The water and the urine is automatically mixed 8-1 part which makes it an excellent fertilizer. The fan draws air through the toilet which makes the bathroom completely odour free, it can also run on a 12 v fan. It can be used without electricity but then you need to install a vent pipe from the toilet above the roof creating a draught. The Separera is delivered in a box with everything needed for the installation: composting chamber, ejector tank with 1,5 m hose, vent pipe, insect-netting, humus starter and installation/use instructions.



Measurements:
H 64
W 40
D 68 cm.

Composting chamber for Separera 33 with cover and handle.



SEPARERA 40

This model looks almost like an ordinary flush toilet and has the same size. The toilet is equipped with a compost cover so when the toilet lid is opened you only see a white cover. When you use the toilet (you always have to sit down) it automatically opens the compost cover and closes afterwards. This model has the composting chamber underneath the floor which allow for larger volume and therefore larger capacity. It is supplied with two composting chambers, while one is being used the other one is placed somewhere else for composting. The toilet has a cover on top where one can put vegetable leavings into the composting chamber.

Measurements: H 69 x W 38 x D 72 cm

The ejector tank for the liquid is placed either out-side the house or underneath the floor. When the ejector tank is full you just hook it up to the garden hose and you can water (fertilize) the lawn. The water and the urine is automatically mixed 8-1 part which makes it an excellent fertilizer. The fan draws air through the toilet which makes the bathroom completely odour free, it can also run on a 12 v fan. It can be used without electricity but then you need to instal a vent pipe from the toilet to above the roof creating a draught. The Separera 40 is delivered in a box with everything needed for the installation: composting chamber, ejector tank, with 1.5 m hose, vent pipe, insect-netting, humus starter and installation/use instructions.